

User manual

MANUEL D'UTILISATION
GEBRUIKSAANWIJZING
GEBRAUCHSANWEISUNG
MANUALE DI ISTRUZIONI
MANUAL DE INSTRUCCIONES
INSTRUKCJA OBSŁUGI
NÁVOD K OBSLUZE

Plego



Content

Content	1
Preface	2
1 Your product	3
1.1 Options.....	3
2 Before use	4
2.1 Intended use.....	4
2.2 General safety instructions.....	4
2.3 Symbols on the wheelchair.....	5
2.4 Transport.....	5
2.5 Folding/Unfolding.....	6
2.6 First use and storage.....	7
3 Using your wheelchair	8
3.1 First ride.....	8
3.2 Driving outdoors.....	8
3.3 Operating console.....	9
3.4 Brake and free-wheel lever.....	10
3.5 Moving to/from wheelchair.....	11
3.6 Comfort adjustments.....	11
3.7 Battery status and charging.....	12
3.8 Switching the electric device On/Off.....	13
3.9 Mounting / removing battery.....	13
4 Installation and adjustment	15
4.1 Tools.....	15
4.2 Manner of delivery.....	15
4.3 Adjusting the footrest.....	15
5 Maintenance	16
5.1 Time of maintenance.....	16
5.2 Instructions for maintenance.....	16
5.3 Troubleshooting.....	17
5.4 Expected lifespan.....	17
5.5 Reuse.....	17
5.6 End of use.....	18
6 Troubleshooting	19
7 Technical specifications	20

Preface

Congratulations! You are now owner of a Vermeiren wheelchair!

This wheelchair is made by qualified and committed personnel. It is designed and produced according to high quality standards guarded by Vermeiren.

Thanks for your trust in the products of Vermeiren. To support you on the use of this wheelchair and its operating options, this manual is offered. Please read it carefully; it will help you to get familiar with the operation, capabilities and limitations of your wheelchair.

If you still have questions after reading this manual, do not hesitate to contact your specialist dealer. He/she will be glad to help you on this subject.

Important note

To ensure your safety, and to prolong the lifetime of your product, please take good care of it and have it checked and serviced on a regular basis.

This manual reflects the latest product developments. Vermeiren has the right to implement changes to this type of product without being imposed to any obligation to adapt or replace similar products previously delivered.

Pictures are used to clarify the instructions in this manual. Details of the depicted product may deviate from your product.

Information available

On our website <http://www.vermeiren.com/> you will always find the most recent version of following information. Please consult this website regularly for possible updates.

Visually impaired people can download the electronic version of this manual and have it read out by means of a text-to-speech software application.



This user manual
For user and specialist dealer



Service manual for wheelchairs
For specialist dealer



EC declaration of conformity

1 Your product



- | | |
|----------------------|---|
| 1. Backrest | 7. Front wheels |
| 2. Operating console | 8. Rear wheels / Driving wheels with motors |
| 3. Armrest | 9. Battery |
| 4. Seat | 10. Identification plate |
| 5. Footrest | |
| 6. Footplate | |

1.1 Options

Contact your specialist dealer about options. He will gladly advise you.

2 Before use

2.1 Intended use

In this paragraph a brief description of the intended use of your wheelchair is given. Additionally, relevant warnings are added to the instructions in the other paragraphs. In this way we would like to make you aware of the possible misuse that may appear.

- This wheelchair is suitable for indoor and outdoor use.
- This wheelchair is designed and produced solely to transport/transfer one (1) person with a maximum weight of 130kg. It is not designed for transportation of goods or objects, nor for any use other than previously described.
- This wheelchair can be operated by the user sitting in the wheelchair, or it can be pushed by an attendant. You should NOT use this wheelchair without attendant if you suffer from physical or mental impairments that may put you, or other people, in danger when driving the wheelchair. For this reason, consult your doctor first and make sure that your specialist dealer is informed about his advice.
- Only use accessories and spare parts approved by Vermeiren.
- Please read all technical details and limits of your wheelchair in chapter 7.
- The warranty on this product is based on normal use and maintenance as described in this manual. Damage to your product caused by improper use or lack of maintenance will cause the warranty to lapse.

2.2 General safety instructions

 CAUTION Risk of injuries and/or damage

Please read and follow the instructions in this manual. Otherwise you may get injured or your wheelchair may get damaged.

Keep the following general warnings in mind during use:

- Do not use your wheelchair if you are under influence of alcohol, medicines or other substances that may influence your driving abilities.
- Be aware that some parts of your wheelchair may get very hot or cold due to ambient temperature, solar radiation, heating devices or due to the motor drive during the ride. Be careful when touching. Wear protective clothing if the weather is cold. After a ride, wait until the wheelchair/motor has cooled down.
- Before switching the wheelchair on, be aware of the environment/situation in which you are located. Adjust your speed to this before driving off. We advise you to use the slowest speed setting to drive indoors. For outdoor driving you can adjust the speed to a suitable speed at which you feel comfortable and safe.
- ALWAYS keep in mind that your wheelchair may stop suddenly due to a discharged battery or a protection that prevents your wheelchair from further damage. Also check the possible causes mentioned in § 5.3. Use your safety belt to prevent injuries.
- Your wheelchair has been tested for electromagnetic compatibility and complies with the standard, see chapter 7. Nevertheless, sources of electromagnetic fields may influence the driving performance of your wheelchair, such as the fields of mobile phones, power generators or high-power energy sources. On the other hand, the electronics of your wheelchair can affect other electronic appliances too, such as alarm systems of shops and automatic doors. We therefore advise you to check your wheelchair regularly for damage and wear, since these may enlarge the interference (see also chapter 5).
- Only drive on flat surfaces where both driving wheels touch the ground and where there is sufficient contact to operate the wheelchair safely.

- Alterations or substitutions should not be made to the wheelchair securement points or to structural and frame parts or components without consulting the wheelchair manufacturer.
- Make sure that your hands, clothes, belts, buckles or jewellery don't get caught by wheels or other moving parts during use.

Be aware that your wheelchair may interfere with some types of anti-theft systems, depending on the settings used. This may cause the shop's alarm to go off.

Any serious incident [MDR (EU) 2017/745 §2 (65)] that has occurred in relation to the device should be reported to the manufacturer and the competent authority of the Member State in which the user and/or patient is established.

2.3 Symbols on the wheelchair

The symbols in following list are applicable to your wheelchair. Symbols can be found in the relevant ISO standard (ISO 7000, ISO 7001 and IEC 417).



Maximum weight of the user in kg



Indoor use only (battery charger)



Maximum safe slope in ° (degrees).



Maximum speed



Type designation



Risk of entrapment

2.4 Transport

CAUTION

Risk of damage

Take action to protect the wheelchair from being damaged during transport.

2.4.1 Moving out of the way

Use the operating console to drive the wheelchair to its destination.

Otherwise, put the wheelchair in free-wheel mode (see §3.4) and use the push bar to move it.

2.4.2 Transport by aircraft

When transporting the wheelchair by aircraft, lock and disconnect the battery before handing the wheelchair over to airport personnel (see §3.9 and §3.8). The battery can remain in the wheelchair. Consult your airline for the correct handling procedure.

2.4.3 Transport by vehicle, as luggage

The best way to transport your electric wheelchair in the car is to fold it and lift it in the car.

1. As the wheelchair user, transfer to a car seat, see §3.5.
2. Remove all moveable parts prior to transport (bags, headrest,...).
3. Store moveable parts safely behind the passenger seat or in the luggage compartment.

4. Fold the wheelchair (see §2.5) and lift the wheelchair in the car (if necessary, with the help of 2 persons) by grasping the fixed parts of the frame.
5. Attach the solid parts of the frame securely to the vehicle.
6. Place the wheelchair in drive mode (engaging the parking brakes) and check that the operating console is switched off.

2.5 Folding/Unfolding

 CAUTION Risk of injuries

- Make sure that your fingers, clothes, buckles won't get trapped during (un)folding.

To unfold the powered wheelchair:

1. Switch OFF the wheelchair.
2. Place the wheelchair upright on the support wheels (1).
3. Pull the seat and backrest apart to unfold the frame until the bracket (2) clicks into place. Make sure that the locking bracket is in locked position.
4. Place the wheelchair on the rear and front wheels.
5. Fold the armrests (3) down until they click into place.
6. Fold the footrest (4) down.
7. Mount any options that had been removed for transport.
8. The wheelchair is now ready for use.

To fold the powered wheelchair:

1. Switch OFF the wheelchair.
2. Remove any loose options.
3. Make sure that the wheelchair is in freewheel position (see §3.4).
4. Press the buttons (5) on the armrests and fold the armrests (3) backwards.
5. Unlock the frame by pressing the bracket (2).
6. Grasp the backrest and seat frame and press them toward each other. Make sure that the wheelchair is standing stable upright on the support wheels (1).
7. Fold the footrest (4) over the battery.
8. In case the armrests are sticking out, adjust the armrests to a more compact position close to the frame.



2.6 First use and storage

 CAUTION Risk of battery damage

- Never completely discharge the battery.
- Do not interrupt the charging cycle; only disconnect the battery charger when the battery is fully charged.
- Make sure that your wheelchair is stored dry to prevent mould from growing and the upholstery from being damaged.
- Check the technical details for storage, see chapter 7.

Ensure that the battery has been fully charged before using your wheelchair, ask your dealer if this has already been done or not. To charge, follow the charging instructions in §3.7.

3 Using your wheelchair



WARNING

Risk of injuries

- First read previous chapters and inform yourself about the intended use. Do NOT use your wheelchair unless you have read and fully understood all instructions.
- In case of doubts or questions, do not hesitate to contact your local specialist dealer, your care provider or technical adviser to help you with this.

3.1 First ride



CAUTION

Risk of injuries and damage

- Always keep the swing range of footrest and operating console in mind to prevent bystanders from being injured or objects from being damaged.
- Always unplug the battery charger from the wheelchair before starting to drive.

- i**
- Make sure that you are familiar with the operation of your wheelchair before using it in crowded and possibly dangerous places. First exercise at a spacious, open area with little bystanders.
 - Investigate the effects of shifting the centre of gravity on the behaviour of the wheelchair, for example on up or down gradients, on laterally sloping ground, or when overcoming obstacles. Obtain support from an attendant.
 - The surface of the controller gets slightly warm during use.
 - While driving backwards, the speed is reduced.

1. Make sure that:

- the wheelchair is on a flat surface;
 - the battery is fully charged, see § 3.7;
 - The motor is coupled, see § 3.4;
 - the wheelchair is adapted to your needs and comfort, see §3.6;
 - you have the proper sitting position, see § 3.5.
2. Follow the instructions in the operating console manual.
 3. Switch on your wheelchair.
 4. Turn the speed control to the lowest speed setting.
 5. Exercise how to drive and make adjustments to the wheelchair.
 6. If you feel confident enough, you can try to drive at higher speed.
 7. Now try to turn, in forward and backward direction. Repeat this a few times.
 8. Make sure that your wheelchair stands stable, when ending the ride.
 9. Switch off your wheelchair.

3.2 Driving outdoors



WARNING

Risk of accident - Adjust your driving behaviour and speed.

- Take the local road traffic law into consideration; it may differ per country. This counts for driving on pavements, unpaved roads or paved roadways.
- Do not drive on roads with heavy traffic.
- Take the weather conditions into consideration. Avoid driving by moist weather, extreme heat, snow, black ice, freezing temperatures; see technical specifications in chapter 7.
- Make sure that you are well visible, also during daylight hours, by using fluorescent clothing and/or by using own lighting at the front and rear side of the wheelchair.
- Be aware of other road users to whom your wheelchair may be an obstacle. Pay special attention during turning and reversing. If you are not acquainted with how to drive backwards, first practice in an open area. Indicate the direction you are intending to go before turning.
- Try to drive straight in small passages to prevent getting trapped.

- Keep the braking distance in mind. Be aware that the braking distance depends on speed, surface, weather conditions, slope and weight of the user.

3.2.1 Cope with slopes, kerbs, obstacles or ramps

 **CAUTION** Risk of injuries by unexpected movement

- Use a restraining safety belt to secure yourself sitting in the wheelchair.
- Pay attention if the road is sandy, has soft ground, holes or gaps that may cause entrapment of the wheels and/or decreasing of the traction of the driving wheels.
- Do NOT drive on slopes, obstacles, steps or kerbs larger than the size described in the technical specifications in chapter 7.
- Always approach a kerb from the front.
- Do not put your wheelchair in free-wheel mode on a slope. The wheelchair may start moving, causing injuries to you or bystanders.
- Do not use your wheelchair on an escalator or stairs.
- Only use ramps approved by Vermeiren and do not exceed their maximum load.
- To safely overcome obstacles or slopes, put the wheelchair in its most upright sitting position.

i When you stop on a slope, the brake will work automatically to prevent the wheelchair from running forward or backward.

CAUTION Risk of damage

- Always park your powered wheelchair on horizontal flat surfaces and on sites that are easily accessible.
- If necessary, take a short run-up to speed up the wheelchair to mount a slope, obstacle, kerb or ramp. Prevent that you or your wheelchair has to cope with a large recoil.
- Make sure that the wheelchair does not touch the ground or ramp due to the inclination of the wheelchair.
- Be aware that the braking distance on downhill slopes can be significantly larger than on level ground.

Procedure

- Start your drive according to the instructions in § 3.1, step 1.
- To move the wheelchair up or down stairs/steps, use lifting equipment or a ramp. If these are not available, it can be lifted manually by at least two persons, grasping the frame firmly with both hands. Do not use the backrest, footplate(s), armrests, or wheels to grasp the wheelchair.
- To cope with obstacles or inclinations:
 1. Adjust the wheelchair to its most stable position, see § 3.5.
 2. Drive as slow as possible to cope with the obstacle or inclination.

3.3 Operating console

i Put the joystick in the neutral (central) position before pressing the on/off button, otherwise the electronics will be blocked. To release this block, switch the operating console off and on again.

1. ON/OFF button
2. Battery charge indicator
3. Speed indicator
4. Horn button
5. Speed decrease button
6. Speed increase button
7. Joystick



3.3.1 Technical protections

For your own safety, and to prevent that the wheelchair gets damaged, movements are monitored by the electronics. This may result in speed decrease or complete stop.

- To avoid accidental battery run down, your wheelchair is equipped with an automatic power shutdown system. This system switches off the operating console automatically when it is not operated for a while. If this occurs, simply switch your console back on.
- Make sure that the free-wheel lever is in braking position BEFORE switching the wheelchair ON. Electromagnetic brakes do NOT function if the wheelchair is in free-wheel mode. This is indicated on the operating console. Driving is not possible.

3.3.2 Driving

1. Press the ON/OFF button (1) to switch on the wheelchair.
2. If the lights of the battery charge indicator (2) and speed indicator (3) go on, the wheelchair is powered and ready to go.
3. Check the battery status indicator. Charge the battery if necessary (see §3.7).
4. Adjust the driving speed: decrease the speed with the speed decrease button (5), or increase the speed with the speed increase button (6).
5. Start moving the wheelchair by operating the joystick (7) slowly forwards/backwards.
6. The speed will increase when you push the joystick further out of the centre.
7. To turn left or right, push the joystick to the left or right.
8. To brake, move the joystick to neutral position.
9. Press the horn button (4) to alert other road users if necessary.
10. After arrival, check the battery status and press the ON/OFF button to switch off the wheelchair.
11. Charge the battery if necessary.

3.4 Brake and free-wheel lever

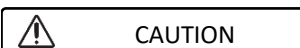

CAUTION

Risk of injuries or damage

- Only operate the free-wheel lever when your wheelchair is turned OFF. An attendant should operate the free-wheel lever. NEVER operate it from sitting position.
- Do not use the free-wheel mode on slopes and inclinations, see symbol on motor.



- i** Make sure that the free-wheel lever is in its braking position BEFORE switching the wheelchair ON. Electromagnetic brakes do NOT function if the wheelchair is in free-wheel mode. This is indicated on the operating console. Driving is not possible.

Your wheelchair is equipped with electromagnetic brakes. The working of the brakes depends on the position of the free-wheel lever (1).

The EM brakes function automatically, **only if** free-wheel lever (1) is in braking position. In this situation, the brakes start braking if:

- the wheelchair is OFF;
- the wheelchair is ON and the joystick is released.

Releasing the joystick makes the wheelchair stop gently and activates the brakes.

Operation of free-wheel lever:



- Turn levers UP to put the wheelchair in free-wheel mode. Now, the motor is disconnected. The wheelchair can be moved manually.



- Turn levers DOWN to connect the motor to the drive. This should be done before starting the wheelchair.

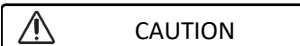

3.5 Moving to/from wheelchair

**CAUTION**

Risk of injuries or damage

- In case you cannot perform the transfer in a safe manner, ask someone to assist you.
- Do not stand on the footplate(s) during transfer into or out of the wheelchair.

Transfer

1. Position the wheelchair as close as possible to you when sitting in your chair, couch, seat or bed.
2. Apply the brakes by turning the free-wheel lever to braking position, see § 3.4.
3. Fold the footplate(s) upwards to prevent standing on them.
4. If necessary, fold back one armrest to make room, see §2.5.
5. Transfer to/from the wheelchair using the strength of your arms or with the help of attendant(s) or lifting equipment.

Sitting in the wheelchair

1. Sit down on the seat with your lower back against the backrest.
2. Turn the footplate(s) down and put your feet on the footplates.
3. Fold down the armrest, if applicable.

Adjusting to stable position

For transport purposes and when you need to negotiate obstacles, the wheelchair must be adjusted to maximise its stability:

- Backrest upright
- Footplate folded up

3.6 Comfort adjustments

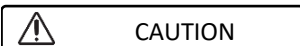
**CAUTION**

Risk of injuries or damage

- The following comfort adjustments can be done by the attendant or caretaker. All other adjustments are done by your specialist dealer according to the installation instructions, see preface.
- Make sure that your fingers, clothes, buckles don't get trapped during adjustment.

3.6.1 Backrest support

The backrest of the wheelchair has a suspension system with adjustable Velcro straps, to adjust the flexibility of the backrest.

1. Pull the backrest cushion from the Velcro straps of the backrest.
2. Loosen the Velcro straps.
3. Pull the respective strap to the desired position. The tension of the individual belts can be varied and the desired support of the back can be set.
4. Place the back cushion back over the backrest starting at the front and ending at the back.
5. Secure the Velcro connections by pressing the cushion against the backrest with your hand.
6. Make sure that all straps are secured with Velcro.

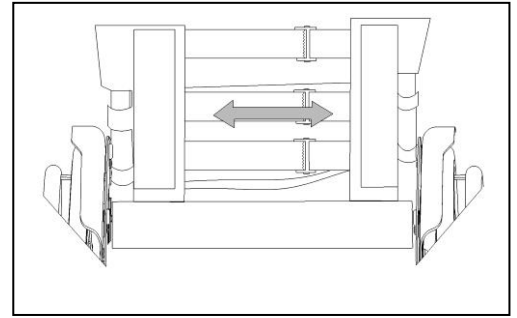

3.7 Battery status and charging

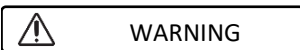

WARNING

Risk of injuries and damage due to fire

- Only use the battery charger delivered with the wheelchair. The use of any other charger may be dangerous (fire hazard).
- The battery charger is only intended to charge the batteries delivered with the wheelchair, not to charge any other batteries.
- Do not adapt any of the delivered parts, like cables, plugs or battery charger. Never open or change the battery or the connection points.
- Protect the battery and battery charger against flames, high and low temperatures (see chapter 7), moisture, sunshine, severe shocks (for example dropping). Do NOT use the battery if this has been the case.
- Charge the battery with the battery charger, indoors, in a well-ventilated area, out of children's reach.

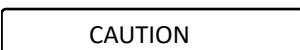

CAUTION

Risk of damage

- Battery self-discharge and the quiescent current of the connected users will drain the battery charge slowly. The battery may be irreversibly damaged if the battery is fully discharged. Therefore, make sure that the battery is charged on time (see 3.7).
- Read the storage and maintenance instructions in chapter 5 and technical details in chapter 7.
- Do not charge batteries below 0°C. Move the battery to a warmer place and start charging.
- Keep the connection point for the battery charger free of dust and other contamination.
- In case of any problems whereby the battery cannot be charged according to following instructions, please contact your specialist dealer.

For all information on battery status indication, please read §3.7.

- i** It is recommended to unplug the battery charger from the mains when not in use. This is to prevent unnecessary energy consumption.

Always check the battery for damage before charging. Press the charge indicator button for 2 seconds to switch on the battery. When no LED of the charge indicator lights up, the battery may be damaged. When at least one, but not all LEDs of the charge indicator, is lit, then fully charge the battery pack before using for the first time.

Do not charge or use a damaged battery, contact your specialist dealer.

To ensure full battery capacity, completely charge the battery with the charger before using it for the first time. The battery can be recharged at any time on the wheelchair or while removed from the wheelchair.

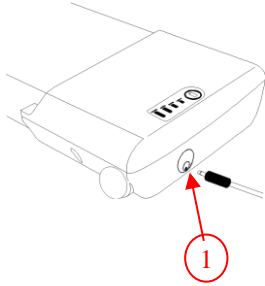

Instructions to charge the battery:

1. Switch the battery off.
2. If desired, remove the battery from the battery housing and prevent dirt or fluids from entering the charging socket.
3. Connect the charger plug to the battery pack ①.
4. Connect the charger mains plug into the wall socket.
5. The LED indicator on the battery charger will show the status of the charging process:
 - Red - Charging
 - Green - Standby / Fully Charged
6. Once the battery is fully charged, remove the battery charger from the wall socket and the battery.

3.7.1 Battery charge indicator

There are two battery charge indicators:

On the battery pack:

1. Press button ② on the battery pack.
2. The LED's of the battery charge indicator ① will indicate the battery charge level.

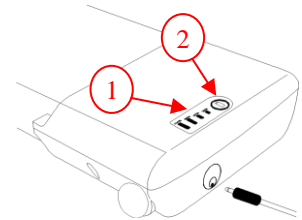

Operator console:

When the electric system is switched on, the battery indicator (2, §3.3) will indicate the battery charge level.

- All LEDs on: battery fully charged.
- Only red LED on or blinking: immediately recharge battery.

Because of the wiring, both indications can deviate a little bit. In that case, take the worst charge level indication.

3.8 Switching the electric device On/Off

Press the on/off switch on the side of the battery.

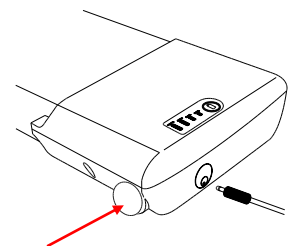

3.9 Mounting / removing battery

The battery can be removed for easy charging away from the wheelchair.

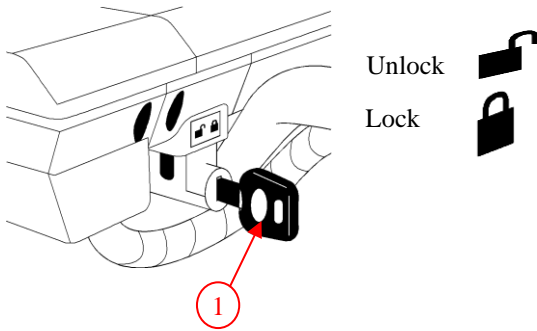

To mount the battery:

1. Place the key ① and turn the key towards the unlock symbol.
2. Place the battery in the battery housing as far as possible. There is only 1 possible way to insert the battery.
3. Turn the key ① to the lock symbol.
4. Make sure that the battery is fixed well.
5. Remove the key ①. (Never remove the key while riding).

To remove the battery:

1. Place the key ①.
2. Turn the key ① to the unlock symbol.
3. Pull the battery gently out of the battery housing.

4 Installation and adjustment

The instructions in this chapter are for the specialist dealer.

To find a service facility or specialist dealer near you, contact the nearest Vermeiren facility.

 **WARNING** Risk of injuries and damage

- Use only the settings described in this manual.

4.1 Tools

To set up the wheelchair the following tools are needed.

- Allen key n° 4
- Wrench key n° 10

4.2 Manner of delivery

The Vermeiren Plego shall be delivered with:

- 1 frame with armrests, rear and front wheels, footrest
- Tools
- Manual
- Accessories (optional)

4.3 Adjusting the footrest

The length of the footrest can be adjusted in 2 positions (20mm range):

1. Remove the screws and nuts (1).
2. Adjust the footrest to the desired length.
3. Retighten the screws and nuts.

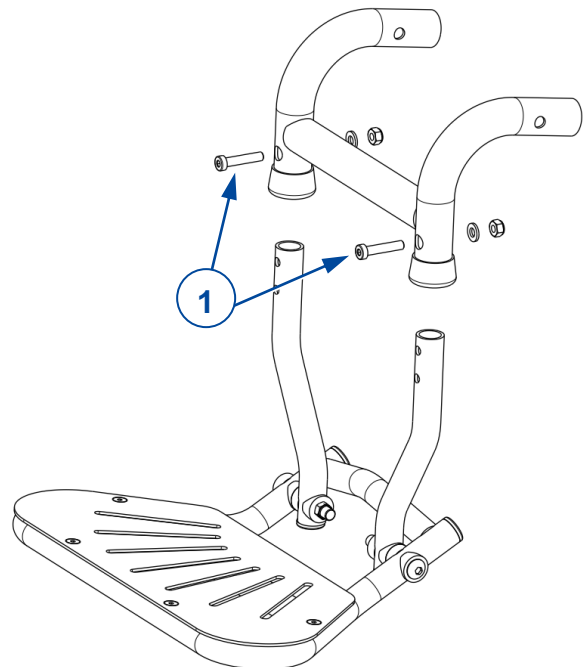

5 Maintenance

5.1 Time of maintenance

 CAUTION Risk of injuries and damage

Repairs and replacements may only be undertaken by trained persons and only genuine replacement parts of Vermeiren should be used.

i The last page of this manual contains a registration form for the specialist dealer to record each service.

The service frequency depends on the frequency and intensity of use. Contact your dealer to agree to a common timetable for inspection/maintenance/repair.

Read the user instructions of the applied battery charger regarding maintenance.

For the maintenance manual, refer to the Vermeiren website: www.vermeiren.com.

Before each use

Inspect the following points:

- All parts: present, undamaged and unworn.
- All parts: clean, see § 5.2.2.
- Wheels, seat, arm rests, footrests and headrest (if applied): well secured.
- Battery status: charge the battery when necessary, see §3.7.
- Operating console, battery, power module, motors, battery charger, lights and relevant cables: no damage such as wires that have become frayed, broken or exposed.
- Condition of wheels/tyres, see § 5.2.1.
- Condition of frame parts: no deformation, instability, weakness or loose connections.
- Seat, backrest, arm pads, calf pads and head rest (if applied): no excessive wear (like dented spots, damage or tears).

Contact your specialist dealer for possible repairs or part replacements.

Every month

If your wheelchair is stored for a longer period, you still need to charge the batteries every month. It is also possible to keep the battery charger connected to the battery and the mains during this period. For more information, see § 3.7.

Yearly or more often

Have your wheelchair inspected and serviced by your specialist dealer, at least once a year, or more often. The minimum maintenance frequency depends on use and should therefore be commonly agreed upon with your specialist dealer.

If stored

Make sure that your wheelchair is stored in a dry environment to prevent mould from growing, or the upholstery from being damaged.

5.2 Instructions for maintenance

5.2.1 Wheels and tyres

i Proper working of the brakes depends on the state of the tyres, that can change due to wear and contamination (water, oil, mud, ...).

- Keep your wheels free of wires, hair, sand and fibres.
- Check the profile of the tyres. If the tread depth is less than 1 mm, the tyres need to be replaced. Contact your specialist dealer for this matter.

5.2.2 Cleaning

CAUTION

Risk of damage by moisture

- Keep the operating console clean and protect it from water and rain.
- Never use a hose or high-pressure cleaner to clean the wheelchair.

Wipe all rigid parts of the wheelchair with a damp cloth (not drenched). If necessary, use a mild soap, suitable for varnishes and synthetics.

The upholstery can be cleaned with lukewarm water and a mild soap. Do not use abrasive cleaning agents to clean.

Keep the ventilation openings of the battery charger clean and free of accumulated dust. Blow away the dust and clean the battery charger enclosure with a slightly moistened cloth, if required.

5.2.3 Disinfection

CAUTION

Risk of damage

Disinfections may only be undertaken by trained persons. Consult your specialist dealer.

5.3 Troubleshooting

Even if you use your wheelchair properly, a technical problem may occur despite this. In this case, contact your local specialist dealer.



WARNING

Risk of injuries and damage to the wheelchair

- NEVER attempt to repair your wheelchair yourself.
- For failures in the operating console you need to contact your specialist dealer. He/She will decide if the console needs to be reprogrammed.

In case of failure, a fault code is displayed on the operating console, see §6.

The following symptoms may indicate a serious problem. Therefore, always contact your specialist dealer if you spot any of the following deviations:

- Strange sound;
- Frayed/damaged wiring harnesses;
- Cracked or broken connectors;
- Uneven tread wear at one of the tyres;
- Jerky movements;
- Wheelchair deflects to one side;
- Damaged or broken wheel assemblies;
- Wheelchair does not switch on (blown fuse);
- Wheelchair is powered but does not move, see 3.4.

5.4 Expected lifespan

The average lifespan of your wheelchair is 5 years. Depending on the frequency of use, driving circumstances and maintenance, the lifespan of your wheelchair will increase or decrease.

5.5 Reuse

Before reuse by another person, have the wheelchair disinfected, inspected and serviced according to the instructions in §5.1 and §5.2.



5.6 End of use

At end of life, you need to dispose of your wheelchair according to the local environmental legislation. The best way to do so, is to disassemble the wheelchair to facilitate the transport of recyclable parts.

6 Troubleshooting

 **WARNING** Risk of injuries and damage to the operating console or wheelchair

- NEVER attempt to repair the operating console yourself.
- For failures of the operating console, you need to contact your specialist dealer. He/She decides if the console needs to be reprogrammed.

In case of a possible problem, a system code is displayed by the blinking LEDs of the battery status indicator, see §3.3 (2). The following table summarises the possible system codes. Some problems can be solved by yourself. For all problems marked in grey, consult your specialist dealer.

Table 2: Troubleshooting

Code	Problem	Meaning
1	Empty battery / bad connection to battery	Check the connections to the batteries. If the connections are good, try charging the batteries.
2	Bad connection of left motor or encoder	Check the connections to the left hand motor and encoder.
3	Faulty wiring on left hand motor / stall condition	
4	Bad connection of right motor or encoder	Check the connections to the right hand motor and encoder.
5	Faulty wiring on right hand motor / stall condition	
7	Joystick fault	Make sure that the joystick is in the centre position before switching on the controller.
7 + S ¹	Communication fault	Make sure that the joystick module cable is securely connected and not damaged.
8	Possible controller fault	Make sure that all connections are secure.
9	Parking brake bad connection	Check the parking brake and motor connections. Make sure the controller connections are secure.
10	Excessive voltage	Excessive voltage is usually caused by a poor battery connection. Check the battery connections.

¹S = Flashing Speed Indicator LEDs.

7 Technical specifications

The technical details below are only valid for this wheelchair, at standard settings and optimal ambient conditions. Take these details into account during use. The values are no longer applicable if your wheelchair has been modified, damaged, or is severely worn. Be aware that the driving performance is influenced by ambient temperature, humidity, slopes (driving up/down), type of surface and battery status.

Table 1: Technical specifications

Brand	Vermeiren
Type	Electric wheelchair, Class A
Model	Plego
Maximum occupant mass	130 kg

Description	Dimensions
Overall length with leg rest	1000 mm
Overall width	595 mm
Overall height	980 mm
Folded length	450 mm
Folded width	595 mm
Folded height	980 mm
Total mass	24,5 kg
Energy consumption *	12,8 Ah: 15 km 17,5 Ah: 21 km
Rated slope	10°
Obstacle climbing	15 mm
Maximum speed forward	6 km/h
Max. braking distance from max. speed	1 m
Seat plane angle	5 °
Effective seat depth	430 mm
Effective seat width	450 mm
Seat surface height at front edge	530 mm
Backrest angle	5 °
Backrest height	460 mm
Footrest to seat distance	440 – 460 mm
Leg to seat surface angle	81 °
Armrest to seat distance	195 mm
Front location of armrest structure	404 mm
Minimum turning radius	1145 mm
Ground clearance	65 mm
Diameter rear wheels	12"
Type of rear wheels **	PU tyres
Diameter front wheels	200x50
Type of front wheels **	PU tyres



Brand	Vermeiren
Type	Electric wheelchair, Class A
Model	Plego
Maximum occupant mass	130 kg

Electrical description	
Battery	12,8 Ah 17,5 Ah
Driving motors	2 x 250W
Blow fuse	20 A
Strength tests according to	ISO 7176-8
Tests of power and control system according to	ISO 7176-14
Ignitability of upholstery according to	EN1021-2:2006
EMC compliance	ISO 7176-21
Degree of protection	IPX4
Noise level	< 65 dB (A)
Storage and use temperature	+5 °C ~ +41 °C
Operating temperature for electronics	-10°C ~ +40°C
Storage and use humidity	30% ~ 70%

We reserve the right to introduce technical changes. Measurement tolerance ± 15 mm / 1,5 kg / 1,5° .

*** The theoretical driving distance will be reduced if the wheelchair is used frequently on slopes, rough ground or to climb curbs.**

****Since different tyres may be used, please note the correct operating pressure of the tyres you use. For other tyre diameters refer to your specialist dealer.**



Vermeiren GROUP
Vermeirenplein 1 / 15
2920 Kalmthout
BE

website: www.vermeiren.com

Instructions for specialist dealer

This instruction manual is part and parcel of the product and must accompany every product sold.

Version: D, 2024-03

Basic UDI: 5415174PlegoCH

All rights reserved, including translation.